

INSTALLATION MANUAL

270L/R290





Important Information

- ✓ This manual includes all the necessary information regarding the installation and maintenance of this product. Please take the time to read it through before operating.
- ✓ When installing the hot water cylinder, please follow the instructions as documented in this manual.
- ✓ Once the installation is complete, check that all connections are secure and the unit is full before the power is turned On.
- ✓ The Installer is to explain to the end user how to operate and maintain the unit in accordance to this Installation Manual.
- ✓ iStore will not be held responsible for any damages or injuries caused by the incorrect installation of this hot water system.
- ✓ It is important that the installation and operational instructions laid out in this manual are strictly adhered to.
- ✓ A maintenance programme must be carried out as recommended in this manual. Failure to comply with these recommendations may void the warranty.
- ✓ This manual could be subject to change without prior notice, if it is felt that product improvements are to be carried out.

Please note that this manual is subject to change. To ensure you have the latest version, please visit our website at <https://heatpumps.istore.net.au/downloads/> or scan the QR code provided here.



Ensure you know your model when referring to the website.



Note your serial number and model here



Serial

Model

Safety Precautions







To prevent personal injury and avoid causing damage to the unit, please take the time to read the information documented in this manual.

ICON	DESCRIPTION
 WARNING	A wrong operation may lead to serious injury or death
 ATTENTION	A wrong operation may lead to injury or loss of material



ICON	DESCRIPTION
	Prohibited (Next to this icon)
	Compulsory - The listed action shall be followed
	Please pay attention to what is indicated





INSTALLATION WARNING

	The iStore shall be installed in strict accordance with local wiring regulations and equipped with a power supply containing a ground/earth conductor.
	The iStore is not intended for use by children, or persons with reduced physical sensory or mental capabilities, lacking relevant skill or experience, without suitable supervision.
	The iStore must be installed by a licensed trade person and in accordance with: <ul style="list-style-type: none"> • This Installation manual • AS/NZS 3500.4 - "National Plumbing and Drainage Code Hot Water Supply Systems-Acceptable Solutions" • AS/NZS 3000 - Wiring Rules • Local authority regulations / EPA guidelines • BCA - Building Codes of Australia • All local Occupational Health and Safety (OH&S) Regulations
	Before installation, check the unit for any damage
	Please ensure that the unit and power connections have a good earth. Failure to do this may cause an electrical shock
	Do not drill any holes or screws into the outer casing. Drilling of any holes will void the warranty



Safety Precautions

 WARNING	<p>This appliance uses R290 (Propane) refrigerant, which is a flammable gas class 3 according to AS1677 and must be handled by refrigeration mechanic with an appropriate Australian handling license.</p> <p>WARNING: Risk of fire/flammable material. If the refrigerant is leaked together with an external ignition source, there is a possibility of ignition.</p>
 Unit Placement	Ensure that the position of the unit is level and in accordance with AS/NZ 3500.4
 Unit Location	The unit CANNOT be installed near flammable gas, naked flames or exposed electric heaters

INSTALLATION WARNING

 Safety Warning	Do not put fingers or any other objects into the fans. Children should be kept clear of this appliance
 Shut Off Power	In the event the iStore has a major malfunction, please shut the power off and contact your iStore Installer or iStore directly

RE-LOCATION OR REPAIR

 Important	If the iStore needs to be relocated, reinstalled or repaired, only use an authorised dealer or qualified persons
 Prohibited	It is prohibited for the end user to repair the unit themselves, unless qualified. Failure to do so may lead to serious injury, damage to the unit, and void the warranty.

CLEANING WARNING

 Shut Off Power	Under no circumstances should water be sprayed directly into the unit when cleaning. Only external surfaces to be cleaned with a soft rag by non-qualified persons.
---	---

Functionality WARNING

	DANGER - High Temperature
---	---------------------------

HOT WATER CAN CAUSE SERIOUS INJURY



WARNING - Hot water is dangerous! As a safety precaution, young children should always be supervised around hot water fixtures

THIS WATER HEATER IS ONLY INTENDED TO BE OPERATED BY PERSONS WHO HAVE THE EXPERIENCE OR THE KNOWLEDGE AND THE CAPABILITIES TO DO SO. THIS WATER HEATER IS NOT INTENDED TO BE OPERATED BY PERSONS WITH REDUCED PHYSICAL, SENSORY OR MENTAL CAPABILITIES I.E. THE INFIRM AND CHILDREN.

As solar water heaters can generate water temperature in excess of 50o C, regulations require that an approved solar rated tempering valve shall be installed in accordance with the valve manufacturer's instructions. This is required to prevent water temperatures supplied to the house exceeding a preset safe maximum. The tempering valve is connected to the hot water outlet lines. The valve must be fitted by an authorised plumber at the time of installation or in retrofitting to existing systems.

CHECK THE WATER TEMPERATURE BEFORE USE, SUCH AS WHEN ENTERING A SHOWER OR FILLING A BATH OR BASIN, TO ENSURE IT SUITABLE FOR THE APPLICATION AND WILL NOT CAUSE SCALD INJURY.

Hot water systems can store water at temperatures that can cause scalding. Water temperatures over 50oC can scald and care needs to be taken to ensure that injuries do not occur through incorrect use of your water heater.

If the water heater is left unused for two weeks or more, a small quantity of hydrogen gas (which is HIGHLY flammable) may accumulate in the top water cylinder. To dissipate this gas safely it is recommended that a sink or bath hot tap be turned on to dispel a couple of litres of water. During this procedure there should be no smoking, open flames or any electrical appliances such as washing machines or dish washers operating nearby. If Hydrogen is discharged through the tap, it will make a sound like air escaping.



GENERAL SAFETY INSTRUCTIONS

The installation of the iStore solar hot water systems requires the expertise of a licensed professional. The installation process must adhere to the guidelines set forth in the National Plumbing code (AS/NZS 3500.4), Australian Electrical Wiring Rules (AS/NZS 3000), as well as all applicable local plumbing and electrical regulations.

The electrically operated components of this water heater operate on 240v AC power.

The removal or attempted alteration of any electrical component must be conducted by a qualified electrical service person.

Care should be taken to avoid coming into contact with any pipe work or fixtures associated with the water heater.

For continued safety of this appliance, it must be installed, operated and maintained in accordance with the manufacturers instructions.



WARNING

This appliance uses R290 (Propane) refrigerant, a flammable gas class 3 according to AS1677.

WARNING: Risk of fire/flammable material. If the refrigerant is leaking together with an external ignition source there is a possibility of ignition.

Compliance with AS/NZS 5601 must be observed during storage.

If a refrigerant leak is detected, switch the unit off at the mains and contact your iStore service agent.

End of life recycling: The refrigerant must not enter the atmosphere and can only be removed by a qualified technician.

Pre-installation checklist

Circuit Selection

- Avoid installing the iStore onto a Controlled Load / Offpeak circuit unless the circuit provides for manual activation of the circuit – no service can be provided without business hours power supply.

Cable Connection

- This unit requires an isolating switch as required by local by laws
- If the power cord is damaged, it must be replaced by a qualified electrician
- Local codes including but not limited to AS/NZS 3000 must be adhered to for all electrical work and be undertaken by a licenced electrician. The licensed electrician deems the circuit is suitable. Adequate overload protection and a residual current device of appropriate size should be installed.
- If the iStore is rated below 10amps and is fitted with a 3 pin plug the electrician may remove the plug if required without effecting the warranty.
- Allow 1m of free cable outside the iStore to avoid noise transfer to the wall and facilitate ease of servicing.

Tank Location

- Place tank on level surface and in accordance with building and plumbing codes.
- To avoid noise transfer:-
 - Do NOT have the iStore touching the wall, 50mm clearance minimum is required.
 - Do NOT have solid electrical conduit attached to the iStore – leave 1m of free coiled flex cable.
 - Do NOT leave pipework loose.
- Consider tank location to reduce any nuisance noise complaints (eg positioning near bedrooms or neighbours' bedrooms)
- Avoid positions where leaf litter and soil can build up in and around the unit.
- Avoid positions where excessive pollen may be sucked into the unit.
- Ensure the minimum space between the unit and walls and objects are per specifications illustrated in Diagram 1a/2a and Diagram 1b/2b.
- Unit shall be located as close as possible to the most frequently used hot water outlet.

Seismic Restraints

- Where required the unit must be braced with with seismic restraints according to local standards
- Only applicable in earth-quake zones

Air Flow

- The iStore requires a minimum of 120 cubic meters of natural ventilation to operate efficiently
- An example would be an area of 8.0m x 6.3m x 2.4m (a large double garage or open space under a home)
- If suitable air flow or area cannot be provided then the performance may be reduced
- External installation is the preferred method to capture the warm ambient air temperature
Air discharge will always be cold
- If unit is being installed internally, provision for fresh air to be introduced shall be provided
450 m³/h minimum requirement

Installation

2.1 Installation space and positioning

Before installation, please ensure that you leave the space as shown below for maintenance.

Diagram 1a. Top View 270L

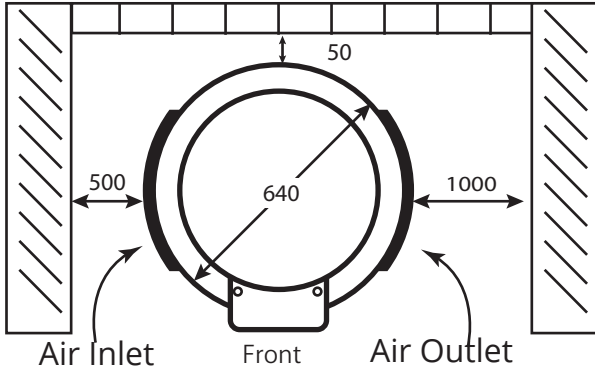

Diagram 2a. Top View 180L

Unit: mm

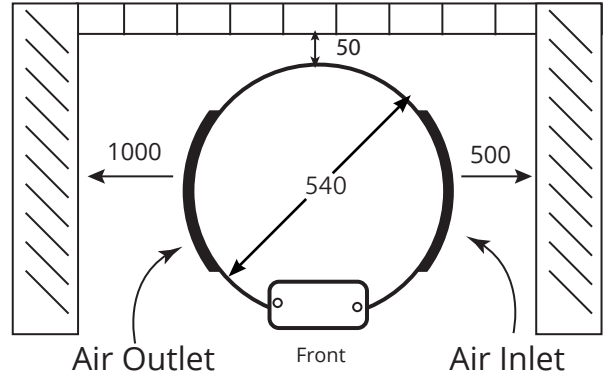

Diagram 1b. Front View 270L

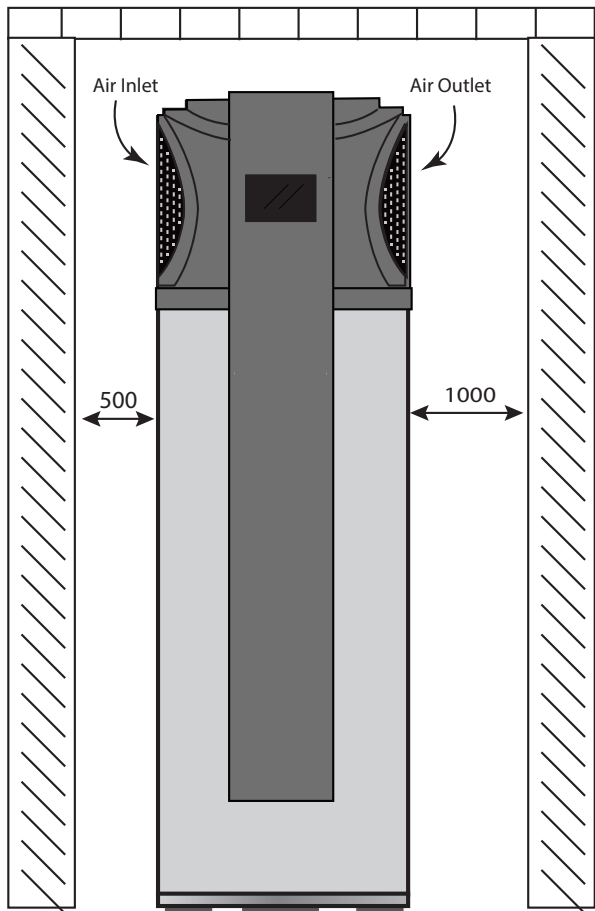
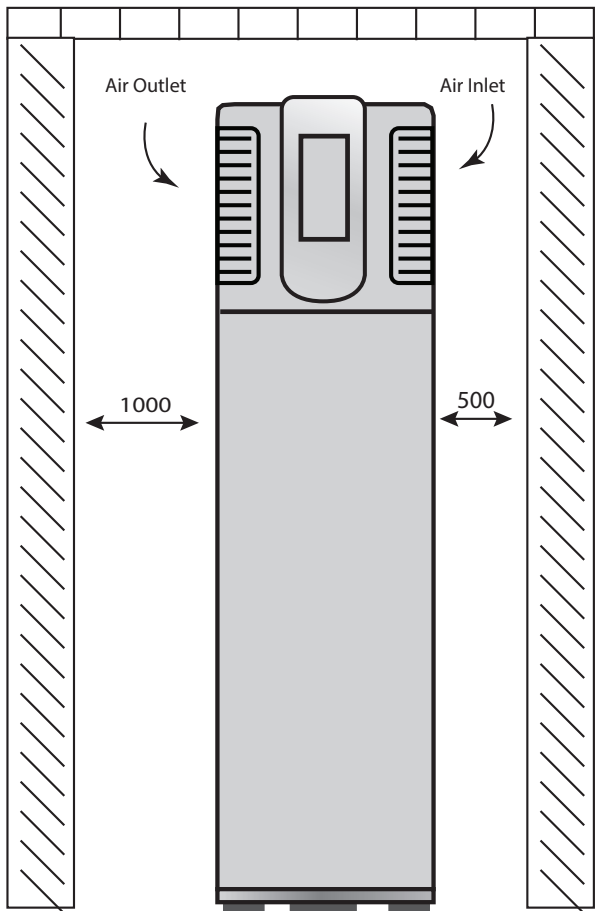

Diagram 2b. Front View 180L

Unit: mm



NOTE – Restricting the air flow on the exhaust side of the iStore can severely effect the performance and longevity of the iStore. If the space is restricted then the iStore must be rotated as close to 45 degrees to the exhaust wall.

Installation

2.2 Dimensions 270L

Unit: mm

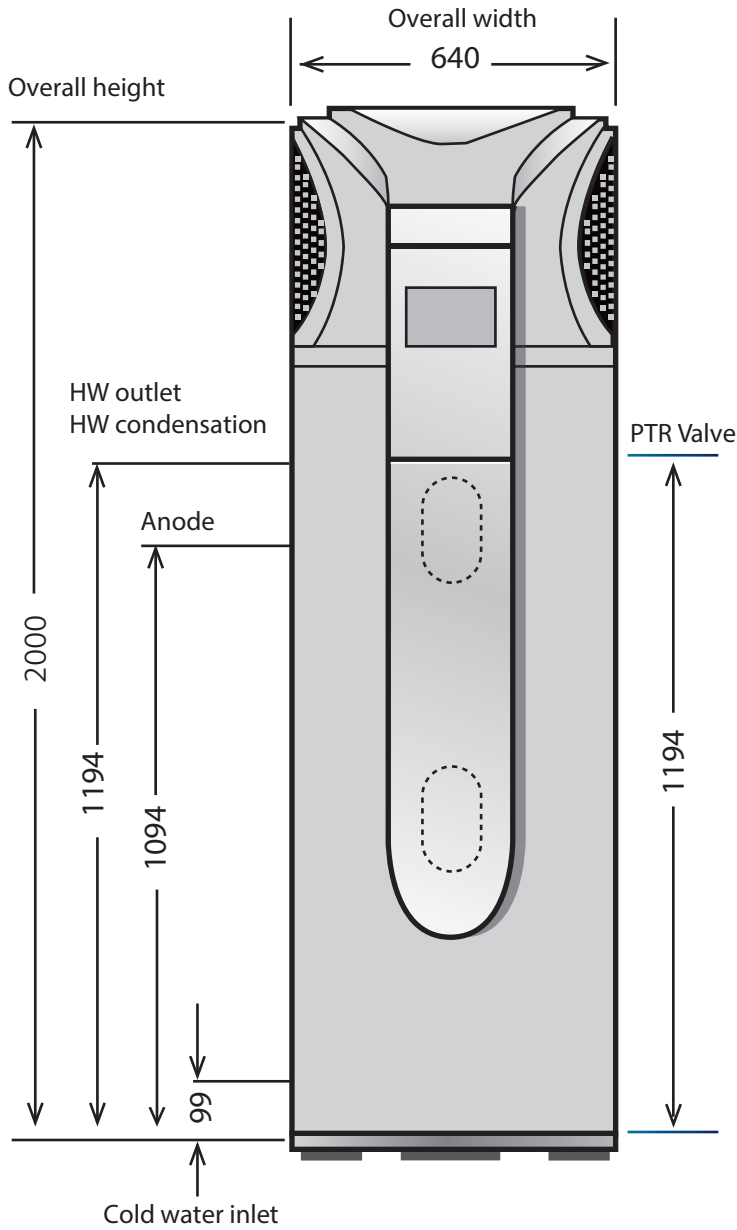

Dimensions	
Height (mm)	2000
Diameter (mm)	640
Height to water inlet (mm)	99
Height to water outlet (mm)	1194
Hot water condensation (mm)	1194
Height to PTR Valve (mm)	1194
Height to Anode	1094
Net weight (Kg)	133

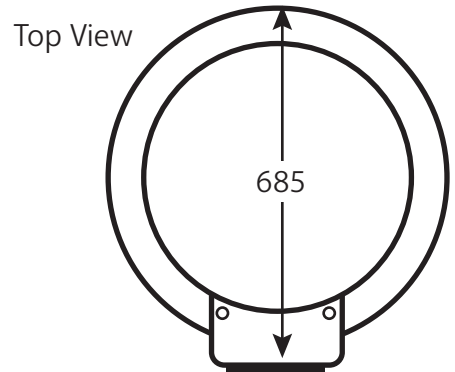

270L iStore

Installation

2.2 Dimensions 180L

Unit: mm

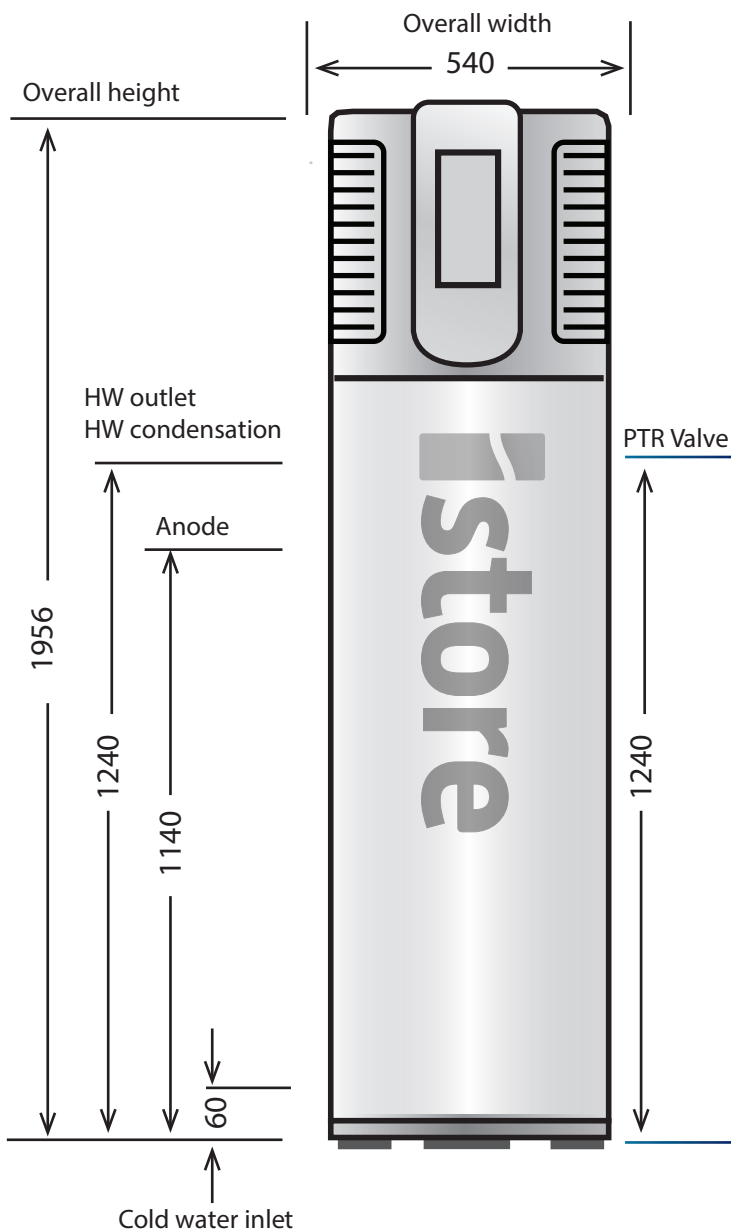

Dimensions

Height (mm)	1957
Diameter (mm)	540
Height to water inlet (mm)	60
Height to water outlet (mm)	1240
Hot water condensation (mm)	
Height to PTR Valve (mm)	
Height to Anode	1140
Net weight (Kg)	93

Top View

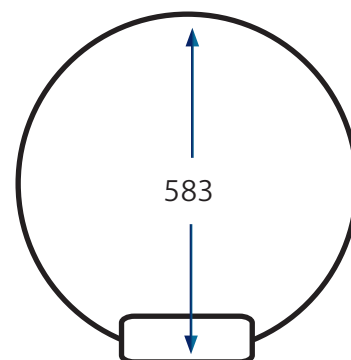

180L iStore

Installation

2.3 Performance Parameters

	Value	180L	270L/R290
Heating capacity	kW	1.7	4.0
Water tank capacity	L	180	270
Compressor power input	kW	0.43	0.85
Compressor running current	A	1.8	3.6
Power supply	V	240	240
Compressor number	Quantity	1	1
Compressor	Type	Rotary	Rotary
Rated outlet water Temp.	C	60	60
Air volume	m ³ /h	700	1000
Noise - Anechoic Chamber	dB(A)	46 @1m	47 @ 1m
Water inlet/outlet size	inch	3/4	3/4
Auxiliary Electric Booster	kW	1.0	1.0
Rated Power Input	kW	1.7	2.38
Rated Current Input	A	7.1	9.9

Installation

2.4 Transportation

- The unit MAY be laid flat during vehicle transportation for short METRO AREA DELIVERIES.
- The unit should NOT be laid flat during vehicle transportation over long distance as damage to compressor mountings and components may occur.
- Check the unit is free of transport damage upon receipt as this damage is not covered by warranty.

Transport Using a Forklift

When transported by a fork lift, the unit must remain mounted on the pallet. The lifting rate should be kept to a minimum. Due to its top-heaviness, the unit must be secured against tipping over. To prevent any damage, the unit must be placed on a level surface!

Manual Transport

For the manual transport, the wooden pallet can be used for bottom part. Using ropes or carrying straps, a second or third handling configuration is possible. With this type of handling, care must be taken that the max. Permissible inclination angle of 60 degree is not exceeded. If transport in an inclined position cannot be avoided, the unit should be placed into operation one hour after it has been moved into final position.

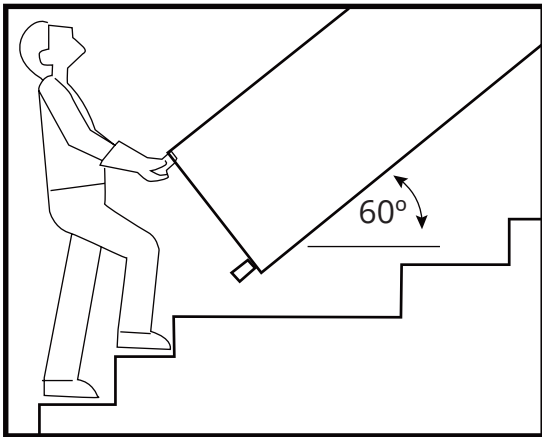

The iStore Heat Pump uses a flammable gas, therefore:

- The appliance should not be stored or transported in an area with an ignition source (e.g. open flame)
- Do not pierce or burn the appliance.
- Be aware of the refrigerant may not cause an odour.
- Compliance with AS/NZS 5601 must be observed while storing the appliance



National and state regulations exist for the storage, transportation and handling of hazardous goods including flammable gasses. The maximum number of and configuration of the equipment permitted to be transported or stored together will be determined by the appliance regulators.

Installation

2.5 Multi-System or Ring Main Configuration



NOTE - DO NOT MIX 270L & 180L

To maintain balance of systems equal length, cold inlet and hot outlets should be installed.

Multi System cold and hot supplies at one location

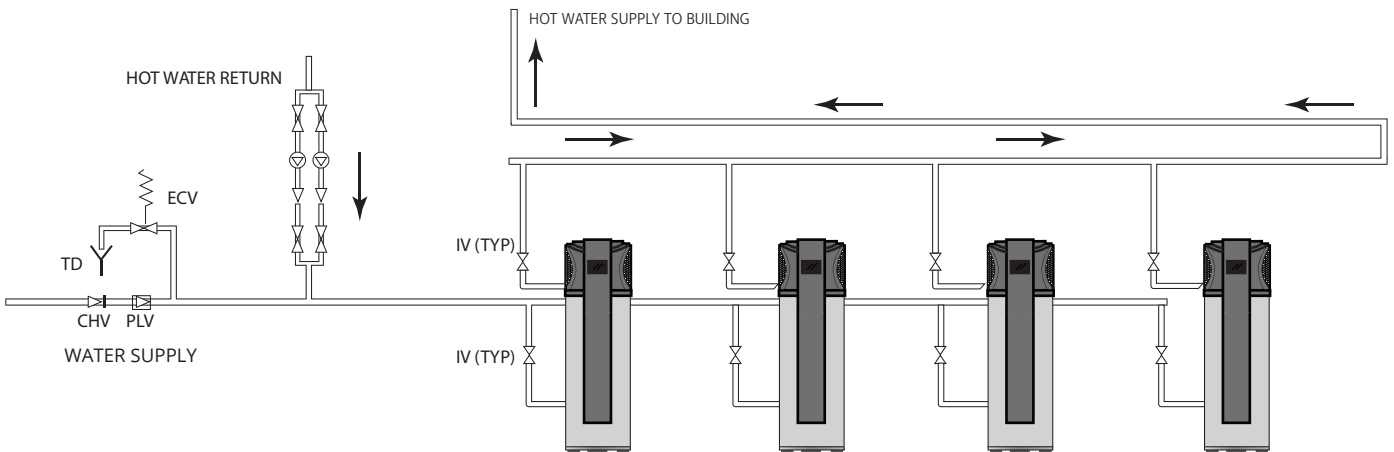

Multi System cold and hot supplies at opposite ends

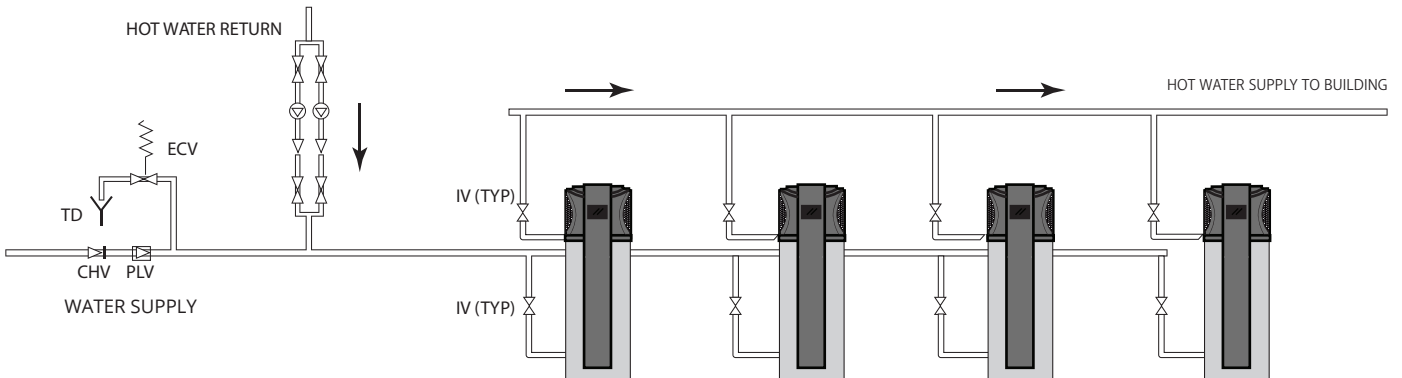

Installation

500kPa Pressure Reduction Valve

Pressure Reduction Valve (PRV 500) - A pressure reduction valve of 500kPa maximum must be fitted immediately downstream of the cold water non-return isolation valve. Failure to install a pressure reduction valve will void the warranty. Please note cold water supply line to the tempering valve must be run after the PRV to ensure equal supply pressure to the tempering valve. This valve is not required shall a 500kPa PRV be installed at the water main supply to the property.

Note: In SA, WA & QLD (and some other areas of other states subject to local authority regulations) it is a requirement that an expansion control valve be fitted between the non-return isolating valve and the water heater.

Working Range

- Operating water pressure 0.15 to 0.7MPa
- Ambient temperature is -5~43°C (compressor)
- The max temperature of water tank is 75°C
- Maximum inlet water pressure is 500kPa
- PTR Valve setting is 850kPa
- ECV Valve setting is 700kPa (if required)

! Hot and Cold Water Connections

All plumbing connections must be performed by a licensed plumber in accordance with local authority regulations.

The cold water inlet connection to the storage tank is 3/4 FI. All pipes and valves must be insulated as per the current AS/NZ 3500.4 Section 8.2. The cold water inlet requires the following valve train please refer to system diagram page for correct installation.

- Approved isolating/non return valve
- 500 kPa Pressure Reduction Valve (PRV) valve
- 700 kPa Expansion Control Valve (ECV)

The maximum inlet water pressure rating is 750kPa. Cold water supply pressures exceeding 500kPa a 500kPa Pressure Reduction valve shall be installed immediately downstream from the Duo valve.

The hot water outlet from the tank is 3/4 inch FI. All hot water pipes must be insulated by UV stable & appropriately rated insulation.

Pressure Temperature Relief Valve (PTR)

An 850kPa, 10kW and 99°C PTR valve is used on the iStore water tank, which is located on the side of the water tank and is essential for its safe operation. The PTR valve is designed to allow 3-5% of total tank volume to discharge during heating to allow for hot water expansion. Water may drip from the discharge pipe of the pressure-relief valve. The discharge pipe must be left open to the atmosphere under all circumstances. PTR Valve the discharge pipe shall be installed downwards and with discharge pipes in a frost free environment. Refer page 15 for how to connect. Seal the thread with approved sealant such as Teflon tape and screw the valve into the correct opening and leave the valve outlet pointing downwards. The discharge pipe diameter is permitted to be run in 15mm copper providing the length of discharge pipe does not exceed 9m.



ATTENTION - It is important that you lift the lever on the PTR valve for a few seconds once every 6 months. It is important you release the lever gently so the valve seat is not damaged.

Installation

2.6 Installation Diagram - Left Hand Install

! UNDER NO CIRCUMSTANCES SHOULD ANY GROMMETS BE REMOVED FROM THE TANK PORTS

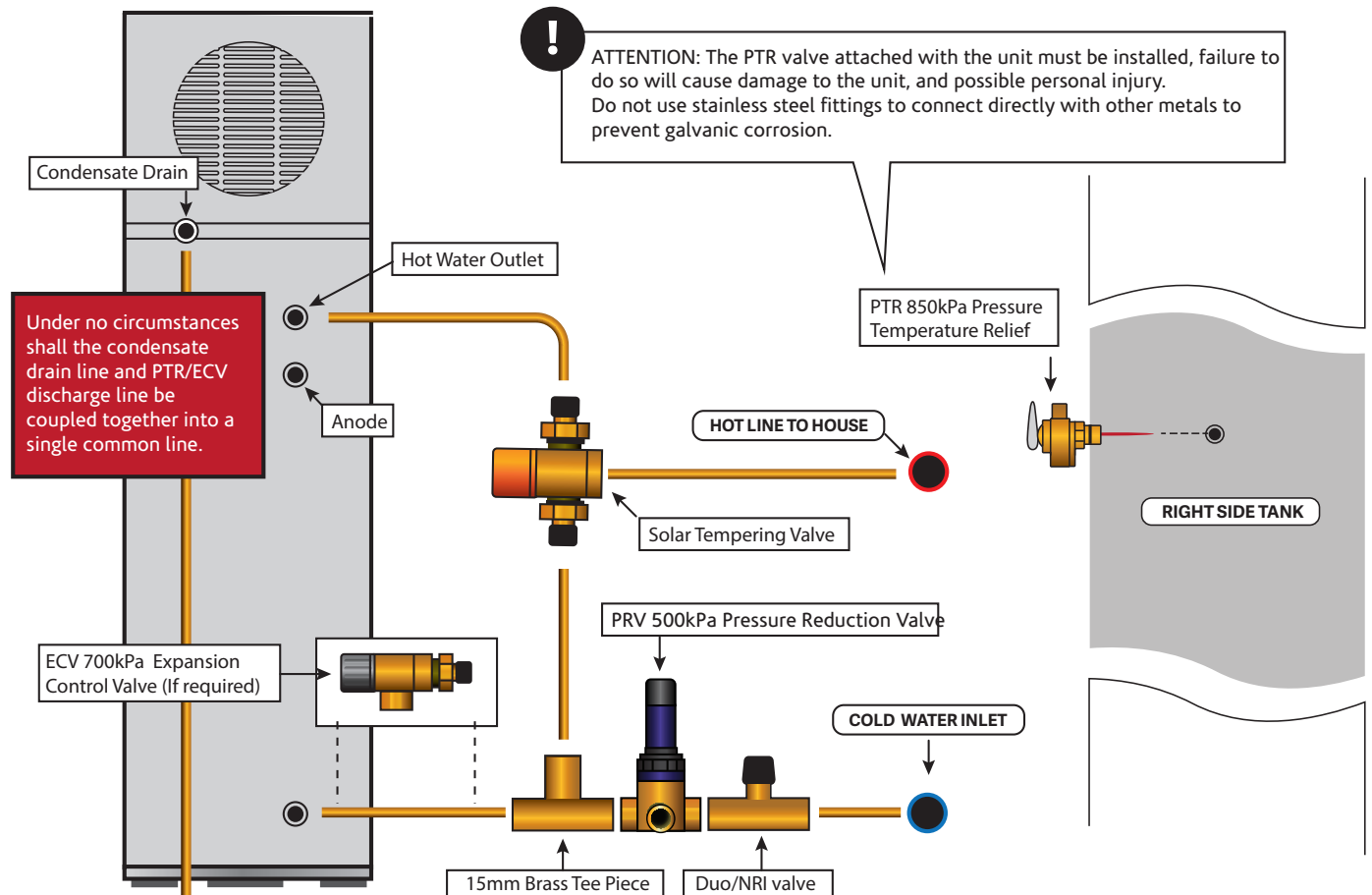

Important Information

- The specification of the water inlet and outlet thread is RBSP3/4 (internal thread)
- The specification of the PTR valve connecting thread is RBSP3/4 (internal thread)
- The specification of the anode and the drain port is GBSP3/4 (internal thread)
- R290 condensate port connection thread is BSP3/4 (external thread)
- 270-LD/270-FL02/180-NM condensate port connection thread is BSP1/2 (internal thread)
- To reduce the risk of blockage from dirt, debris, and pests it is recommended not to reduce the condensate water pipes where possible
- Condensate drain shall discharge to an approved discharge point

Filling and Commissioning the iStore Hot Water System

1. Turn on the cold water supply to the tank and open a hot water tap preferably laundry tap without filter as existing sediment may partially block pre-existing water saving devices. Do NOT bleed the tank via the PTR.
2. Leave the house tap open until all air is bled, then turn off hot water tap.
3. Only after bled via the house tap should the PTR Valve (Pressure relief valve) be activated to ensure system is fully bled of all air.
4. Once the system is fully pressurised with water, thoroughly check all fittings, connections and pipework for water leaks.

Installation

Inspection Before Trial Running

- ✔ Make sure the unit is full of water
- ✔ Check the water supply to the tank and pipe connections for possible leaks
- ✔ Check that all power connections are secure before switching on

Trial Running

- ✔ Switch on the unit from the LCD
- ✔ In the case of any unusual noise, switch the power off and consult your iStore technician
- ✔ The parameters have been preset to a temperature of 60 degrees

iStore Basics

How it works

1. A fan draws in air, containing heat energy, across the evaporator.
2. The evaporator turns the liquid refrigerant into a gas.
3. The compressor pressurises the refrigerant into a hot gas.
4. The hot gas inside the condenser coil heats the water inside the coil-wrapped tank.
5. The refrigerant reverts back to a liquid after heating the water and continues to the evaporator for the process to start again.
6. The cycle continues until the set target temperature is achieved.

As water is used in the home, the cycle will restart once the temperature in the lower section of the tank has dropped 12 degrees below the target temperature.



Safety Features and general information

Smart Screen Lock

Important – If the iStore display does not detect activity for 60 seconds the screen will enter sleep mode which requires a simple palm press AND RELEASE on the LCD to reactivate it.

After a further 2 minutes of inactivity the screen will lock to prevent unwanted changes.

Start up delay protection

If the unit stops and you restart the unit or turn it on by the manual switch, the unit will not start to run again for approx. 3 minutes. This is a protection feature to safeguard the compressor.

Defrost mode

In the heating mode the unit will defrost automatically, maximizing the heating efficiency (Lasting 2 - 10 minutes). The fan motor will stop running whilst the unit is defrosting.

NOTE: a fog or mist may occur during the defrost cycle during cold weather.

Working conditions

In order to use the unit correctly, please operate the unit at ambient temperature of -7° ~ 50° Celsius.

Thermal cut-off safety device

If the water temperature reaches 85° C, the power of unit will be cut off (refer to manual to reset).

Condensation

During normal operation, condensation occurs from the transfer of air across the evaporator coil. This process is drawing humidity from the air and creates condensation/water droplets on the coils, which in turn is captured in the fully moulded condensate tray and discharged through the condensate drain line. In locations with humidity greater than 80%, up to 5 litres per day can be expected under normal operating conditions.

Functionality

4.1 The Function Diagram Of The LED Display

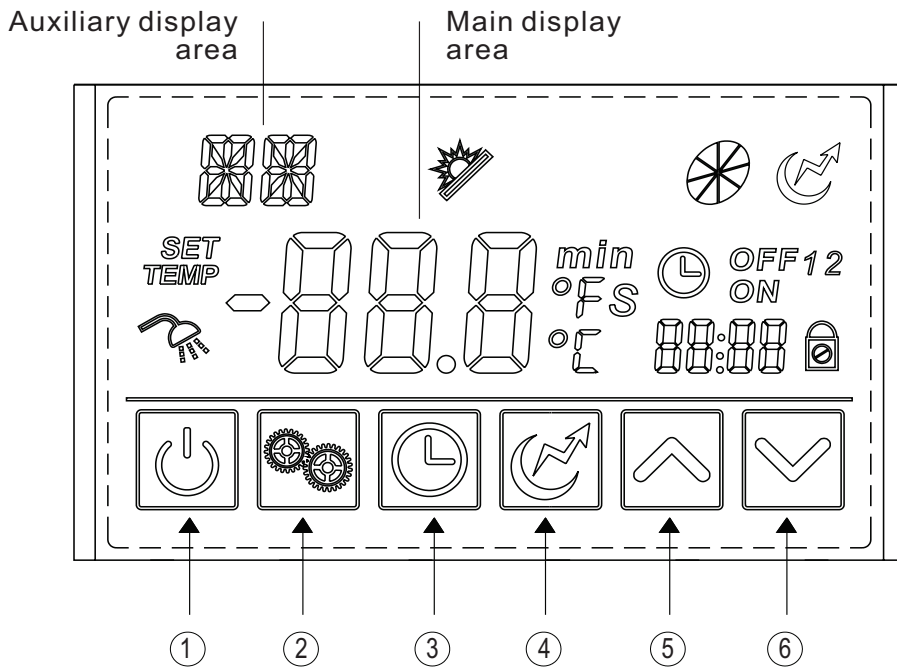

Function of keys







NO.	Button	Name	Function
①		ON/OFF	Turn on/off the unit.
②		Mode	Save parameter settings.
③		Clock	Set the clock or the timer.
④		Electric Booster	Turn on/off the electric booster.
⑤		Up	Move up or increase parameter values.
⑥		Down	Move down or decrease parameter values.



Find the LCD function video tutorials on our website.
<https://heatpumps.istore.net.au/lcd-setup-tutorials/>



Functionality

Status icon	Name	What it means
	Eco Mode	Shows that the unit is in eco heating mode.
	Fan	Shows that the fan is on and the speed of the fan.
	Electric Booster	Shows that the electric booster is on.
	Set temp. achieved	Shows that the water temperature has reached the target point and the unit shut off automatically.
<i>SET</i>	Parameter setting	Shows that the parameter is adjustable.
<i>TEMP</i>	Temperature	Shows that the temperature is non-adjustable (measured value).
	Timer & ON	Shows that the unit will be turned on by the timer automatically.
	Timer & OFF	Shows that the unit will be turned off by the timer automatically.
<i>min</i>	Minute	Shows that the main display area displays the minute.
<i>°C</i>	Centigrade	Shows that the temperature in Main display area or Auxiliary display area is in C
	Lock	Shows that the keyboard is locked.

The general operation of the iStore is that when the bottom of the tank temperature, the top left number, falls more than 12 degrees below the target temperature, the iStore will commence heating and heat the full tank to the target temperature.

Once achieved, the shower symbol  will appear on the left side of the LCD.

The large centre number is the temperature towards the top of the tank, please remember that hot water rises and is drawn from the top of the tank to be delivered to the house for use.

Note - If the padlock symbol  is displayed that the screen will display all values but cannot be changed.

The power button  in the bottom left of the LCD can operate in 3 ways.

- A 6 second hold will lock or unlock the lcd screen
- A 2 second press and release will turn the iStore On or Off
- A short tap will exit whichever function you are changing

Functionality

continued from previous page ...

The mode button  only responds to a short tap.

The clock button  can operate in 3 ways,

- A short tap tells the iStore that you wish to change the system clock
- A 2 second press and release enters the timer setting mode
- By holding the button continually the LCD will rotate thru each of the timer settings. It will progress through On 1 time, the Off 1 time, followed by the On 2 time, and Off 2 time, until you let go of the button.

The booster button  is turned On or Off by a short tap on the button.

The up and down arrows   are used to adjust the clock and the timer.

4.2 The LCD Lock/Unlock function

! Important – If the iStore display does not detect activity for 60 seconds the screen will enter sleep mode which requires a simple palm press AND RELEASE on the LCD to reactivate it.

After a further 2 minutes of inactivity the screen will lock to prevent unwanted changes.

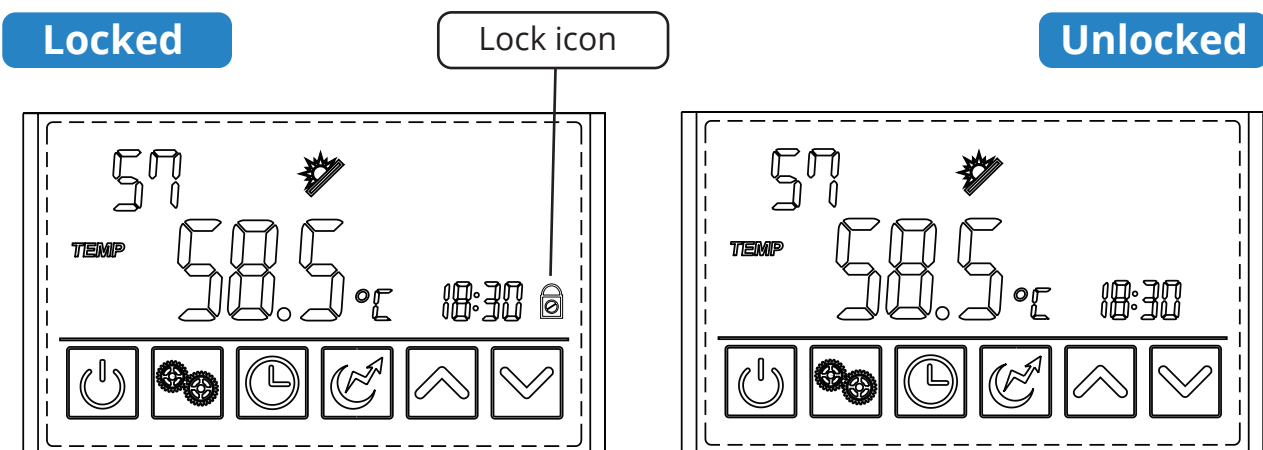

To unlock the screen simply press and hold the power  button for 6 seconds.



Find the LCD function video tutorials on our website.

<https://heatpumps.istore.net.au/lcd-setup-tutorials/>



Functionality

4.3 Turn ON/OFF the unit

Press  and hold for 0.5s and the LED display will turn on the unit and at this time the main display area shows the water outlet temperature.

Press  and hold for 0.5s in the running interface and the LED display will turn off the unit and at this time the main display area shows OFF.

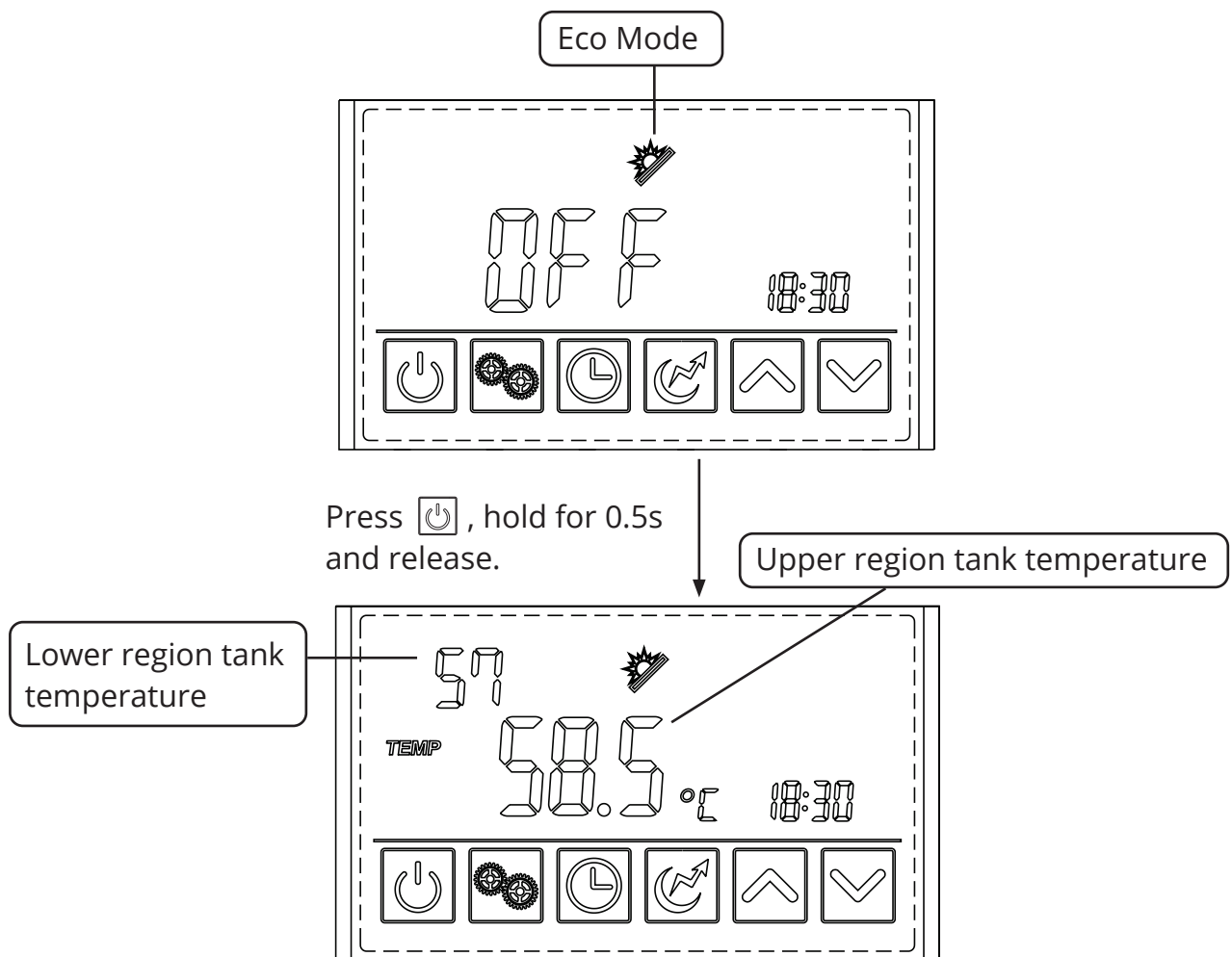

Find the LCD function video tutorials on our website.
<https://heatpumps.istore.net.au/lcd-setup-tutorials/>



Functionality

Mode selection

The Federal Government Clean Energy Regulator specifies how the iStore compressor hot water systems must operate in Australia and as such how the computer control operates.



Economic Heating Mode

For Australian conditions ECO mode monitors the surrounding temperature, incoming water and outgoing water, heat transfer capabilities and adjusts its operation to suit.



Electric Element Booster Mode

The electric element will heat the water to the pre-set temperature and turn off once this is reached. The electric element booster mode is classified as a one-shot boost and will automatically turn off once the target temperature is reached.

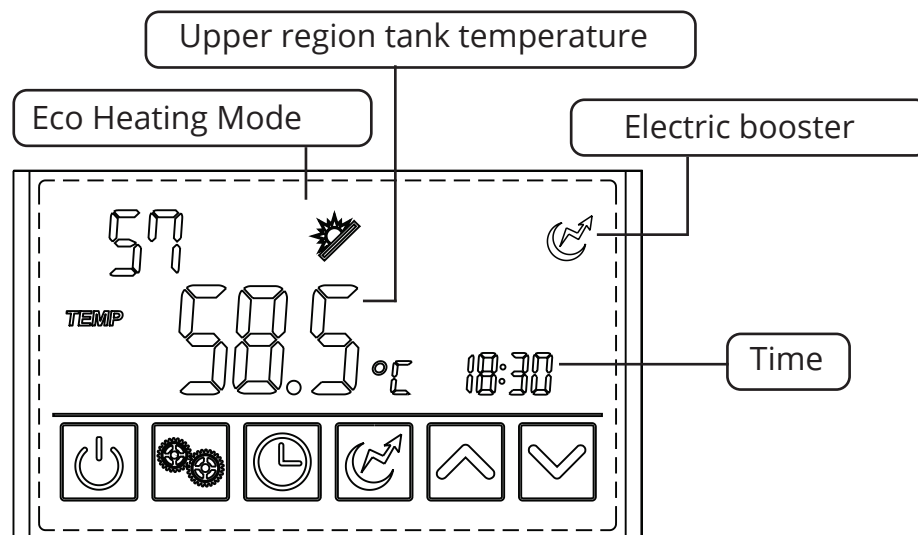

Find the LCD function video tutorials on our website.

<https://heatpumps.istore.net.au/lcd-setup-tutorials/>





Functionality

4.4 Setting the Time & Date

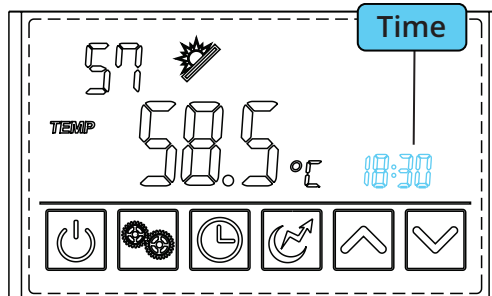

Example: Change the time and date from 18:30 on August 4th to 17:40 on September 8th.

Tap the clock button  and the whole digital clock will flash

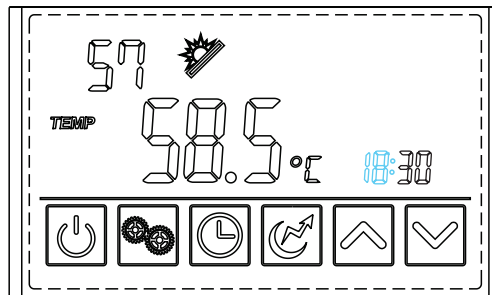

Tap the clock button  again and the hours will flash



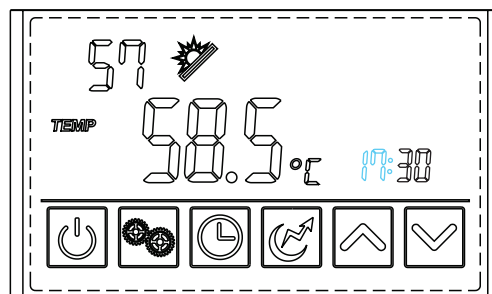

Tap the up or down arrows   to adjust the hour

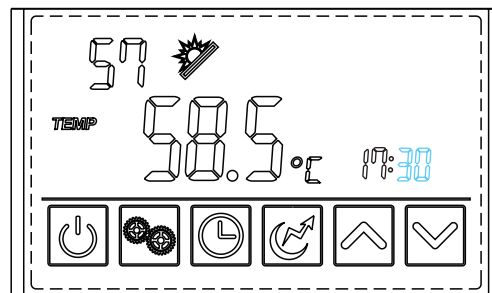

Tap the clock button  again and the minutes will flash



Tap the up or down arrows   to adjust the minutes

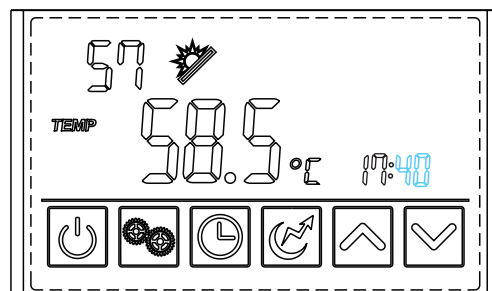

Functionality

4.4 Setting the Time & Date

Tap the clock button  again and the whole month and day will flash

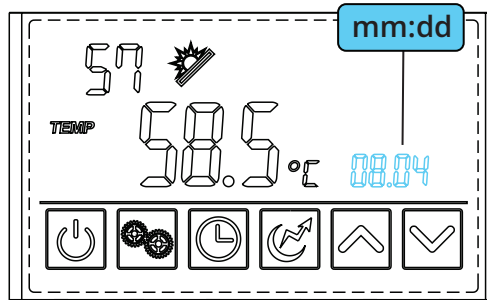

Tap the clock button  again and the month will flash

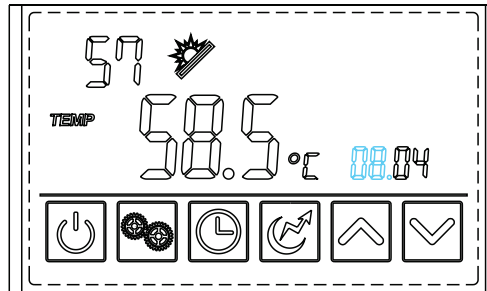

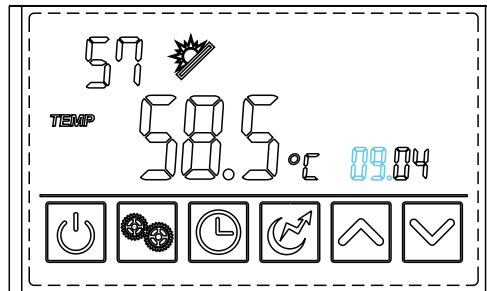

Tap the up or down arrows   to adjust the month

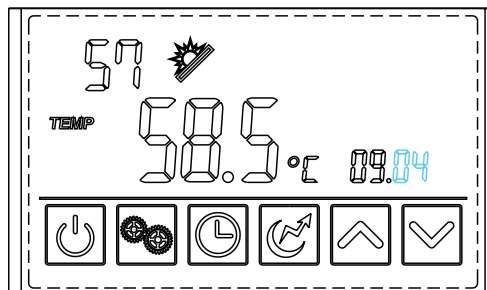

Tap the clock button  again and the day will flash



Tap the up or down arrows   to adjust the day

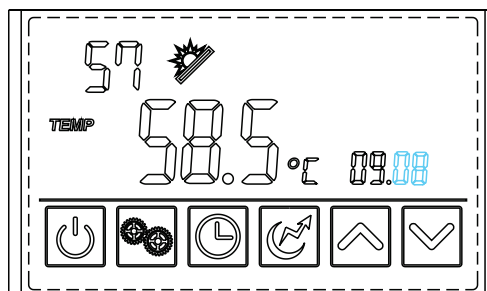

CONTINUED

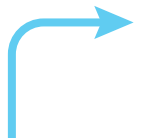

Functionality

4.4 Setting the Time & Date

CONTINUED

Tap the clock button  again and the whole year will flash

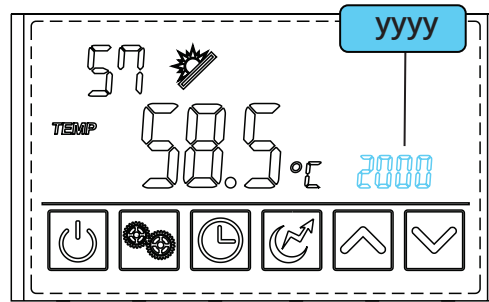

Tap the clock button  again and the year will flash

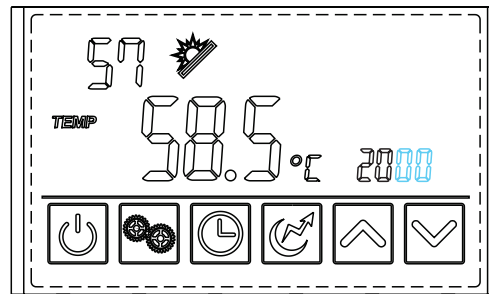

Tap the up or down arrows   to adjust the year

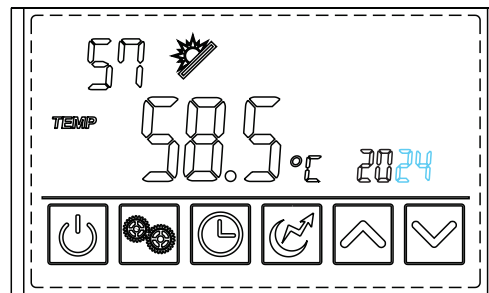

Tap the clock button  to complete the timer setting

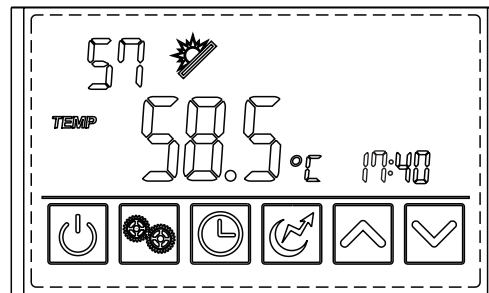

Find the LCD function video tutorials on our website.

<https://heatpumps.istore.net.au/lcd-setup-tutorials/>



Functionality

4.6 Timer Setting (Eco Mode)

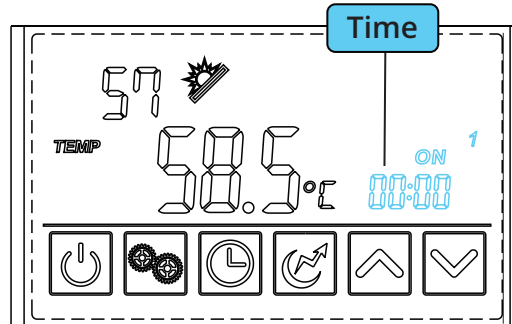

! **NOTE:** A timer is not mandatory for the iStore operation. Factors such as household demand, time of use, individual supplier peak and offpeak electricity rates, solar panel Feed In Tarrif rates all may influence what heating schedule best suits a household

Press and hold the clock button  for 2 seconds until **ON, 1** and the whole digital clock will flash

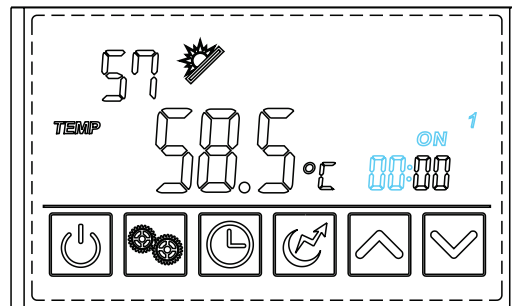

Tap the clock button  and the **ON 1** hours will flash



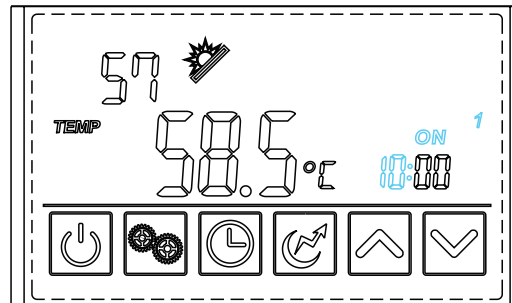

Tap the up or down arrows   to adjust the **ON 1** hour

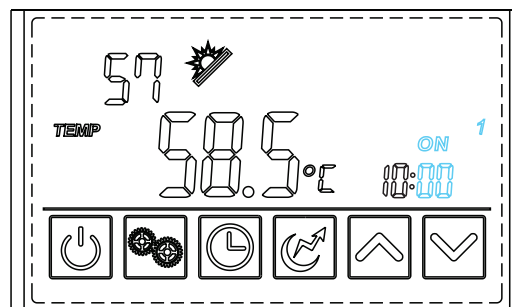

Tap the clock button  and the **ON 1** minutes will flash



IF REQUIRED tap the up or down arrows   to adjust the **ON 1** minutes

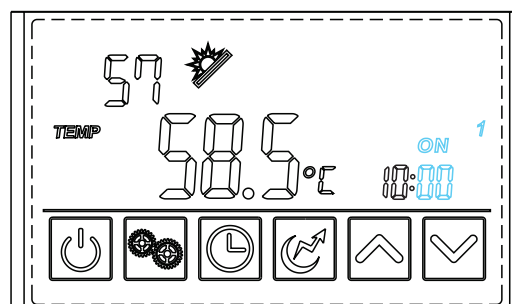

CONTINUED

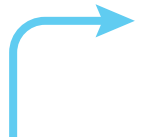

Functionality

4.6 Timer Setting (Eco Mode)

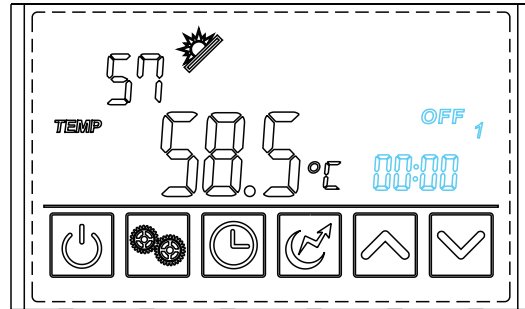

CONTINUED

Tap the clock button  and the **OFF 1** and the whole digital clock will flash

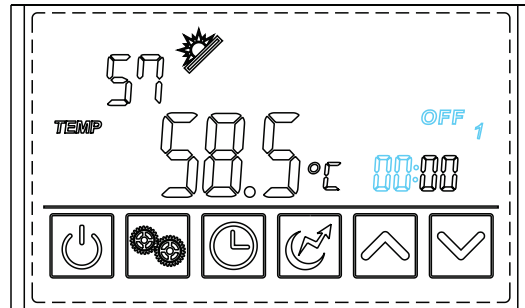

Tap the clock button  and the **OFF 1** hour will flash



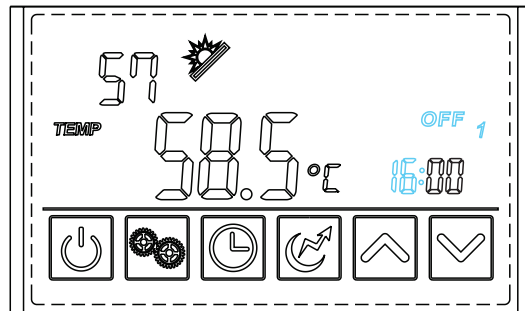

Tap the up or down arrows   to adjust the **OFF 1** hours

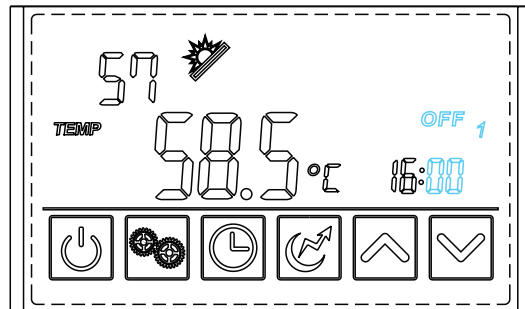

Tap the clock button  and the **OFF 1** minutes will flash



Tap the up or down arrows   to adjust the **OFF 1** minutes

Ensure that the **OFF 1** minutes are different to the **ON 1** minutes

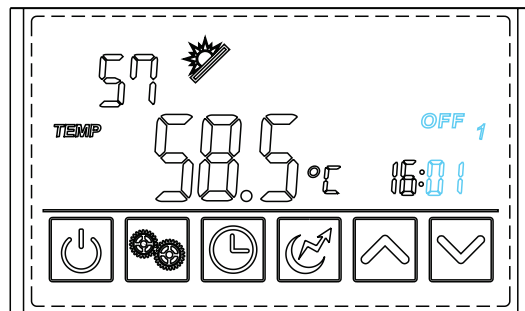

Functionality

NOTE: IF YOU ONLY REQUIRE 1 TIMER THEN YOU MAY LET THE TIMER FUNCTION TIMEOUT AND THE SECOND TIMER WILL REMAIN BLANK WITH "--:--" VALUES.

If you require a second timer then tap the clock button again and step through setting the **ON 2** and **OFF 2** times as described on the previous page.

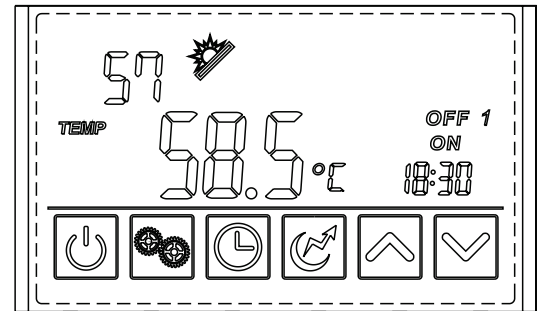

! Important Information

For units manufactured from January 2023 ignores timers with the same start and end time, that is 00:00 on through 00:00 off will not activate as 12:00 on thru 12:00 off will also not activate.

On and off times should have differing minutes also to ensure the desired period is achieved.

For example for a full daytime timer a start of 10:00 on thru 16:00 should have the minute increased to 16:01 to confirm the timer window operation.

For units manufactured prior to January 2023 do not set the second timer to 00:00 ON and 00:00 OFF as the unit will commence heating at midnight every second night.

! Why don't my timer changes take effect?

If you are setting the timer and you are currently outside of the timer you wish to have, you will need to switch the unit to the OFF state by a 2 second press on the power button and let go. Conversely if you are adjusting it so the current time is inside the timer window, you may need to switch the unit to the ON state by a 2 second press on the power button and let go.

If you have shortened the timer but not switched it to the OFF state then the unit could reheat based on water usage until the next time the timer window turns ON and then OFF.

If you have lengthened the timer but the unit is still OFF then you will need to switch the unit to the ON state otherwise no heating will occur until the next time the timer window turns ON and then OFF. When the timer ON time is reached it activates the display and will show the temperatures etc, at the end of the timer window the display will return to the OFF state.



Find the LCD function video tutorials on our website.

<https://heatpumps.istore.net.au/lcd-setup-tutorials/>



Functionality

Timer setting summary (Eco Mode)

Press and hold the  button 2 seconds, the "ON" and "1" will flash,

ON 1

tap the  and the hour value will flash, adjust the hour up or down with the   buttons

tap the  again and the minute value will flash, adjust the minute up or down with the   buttons

OFF 1

tap the  again and the full hh:mm will flash,

tap the  again and the hour value will flash, adjust the hour up or down with the   buttons

tap the  again and the minute value will flash, adjust the minute up or down with the   buttons

NOTE: IF A SECOND TIMERS IS NOT REQUIRED ALLOW THE LCD TO TIME OUT AT THIS POINT

ON 2

tap the  again and the full hh:mm will flash,

tap the  again and the hour value will flash, adjust the hour up or down with the   buttons

tap the  again and the minute value will flash, adjust the minute up or down with the   buttons

OFF 2





tap the  again and the full hh:mm will flash,

tap the  again and the hour value will flash, adjust the hour up or down with the   buttons

tap the  again and the minute value will flash, adjust the minute up or down with the   buttons

tap the  again and the LCD will return to ON 1, allow the LCD to time out at this point.

When the LCD returns to the default state the display will indicate whether 1 or 2 timers are set just above the digital clock, e.g.

Timer settings	
1 timer	 OFF 1  ON
2 timer	 OFF 12  ON



Find the LCD function video tutorials on our website.

<https://heatpumps.istore.net.au/lcd-setup-tutorials/>



Functionality



EXAMPLE ONLY: *Running period 1: 10:00 ~ 16:01; Running period 2: 00:00 ~ 03:01.*

To review the timers press and hold  button, do not release, the LCD will display each of the four ON and OFF times in order. Release the button after review and let the LCD time out.

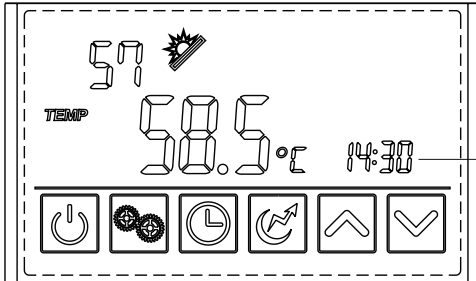

Current time

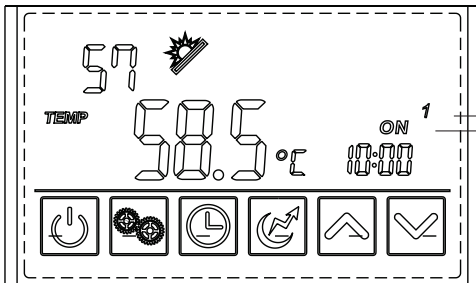

ON1

Press and hold clock button  and do not release

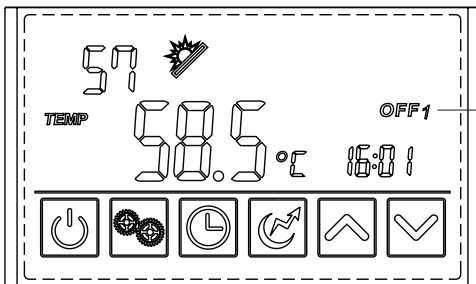

OFF1

Continue to hold clock button 

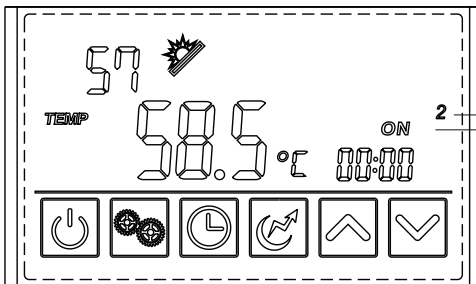

ON2

Continue to hold clock button 

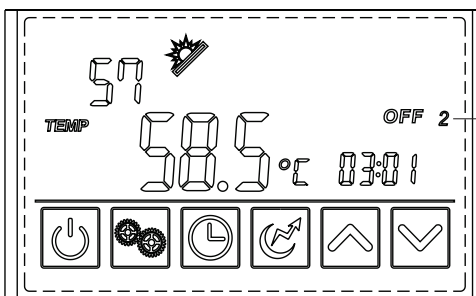

OFF2

Continue to hold clock button 

Allow the timer review function to timeout and return to the normal display.



NOTE: Do not set the second timer to 00:00 ON and 00:00 OFF as the unit will commence heating at midnight every second night. To leave the second time off simply allow the timer setting to timeout after setting the first timer end time.

Functionality

5.6 Cancelling the Timer Setting

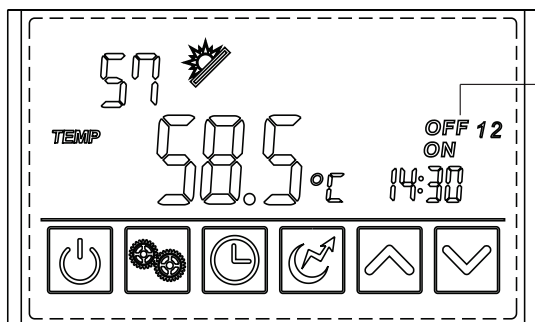

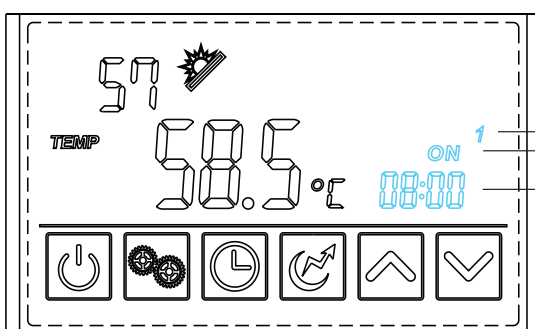

Timer state

Press and hold the clock button  until the timer flashes

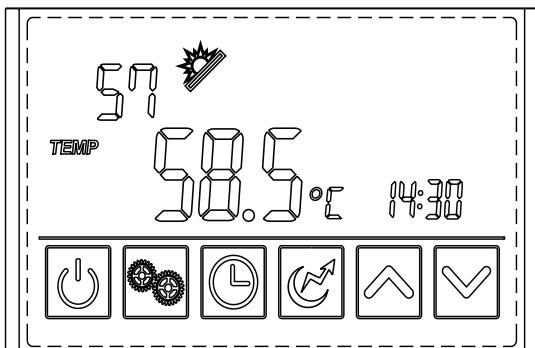

The ON, 1 and timer 1 will flash





Tap the power button  to cancel the timer operation.

Functionality

Electric booster setting

The Federal Government Clean Energy Regulator states that the manual booster may only remain active for the single heat cycle until the target temperature is reached.

The Federal Government mandates a thermostat range of 12 degrees for the iStore, for the electric booster this is measured in the upper region of the tank displayed in the centre of the LCD. The heat cycle will not commence until the water in the upper region falls 12 degrees below the target temperature. Note if you engage the electric booster within the 12 degrees it will not operate.

The electric booster can be turned on when the unit is heating or standby. Press  once to turn on the electric booster and press  again to shut it off.

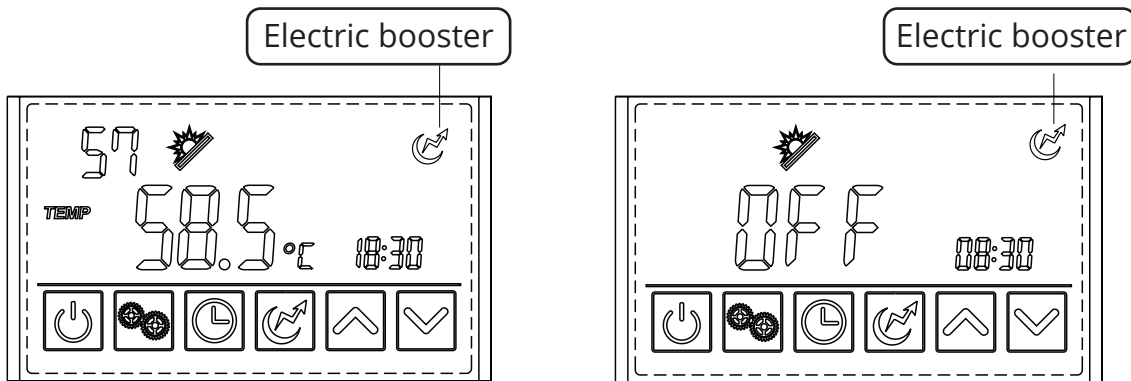

Anti-legionella Protection Cycle

To comply with the Australian storage hot water regulations all manufacturers must comply with anti-legionnaires protection within their product. The iStore utilises the compressor heating system as the method to achieve the compliance due to its high efficiency.

Further Assistance? Go to the FAQ

Need some further assistance then please review the extensive Frequently Asked Questions at <https://heatpumps.istore.net.au/frequently-asked-questions>



Home Owner Maintenance

Temperature and Pressure Relief valve PTV/PTR (all tanks)

The iStore Hot Water system is fitted with an 850kPa PTR Valve, which is located on the side of the cylinder and is essential for its safe operation. It is important that you operate the lever on the PTR valve for a few seconds once every 6 months. It is important you release the lever gently so the valve seat is not damaged.

Expansion Control Valve (ECV) (if applicable)

In some states and local councils, the installation of an Expansion Control Valve (commonly referred to a cold-water expansion valve) is required to be installed. If this valve is fitted, follow the same procedure for PTR valve as explained above.

Condensation line

Regularly inspect the condensation line to ensure water is dripping freely for the line. If the condensate drain is blocked at the discharge end, clear any debris that may have collected in the line. During normal operation, condensation occurs from the transfer of air across the evaporator coil. This process is drawing humidity from the air and creates condensation/water droplets on the coils, which in turn is captured in the fully moulded condensate tray and discharged through the condensate drain line. In locations with humidity greater than 80%, up to 5 litres per day can be expected under normal operating conditions.

Obstructions

Regularly check the no obstructions are interfering with the air in-take or air discharge. If unit is installed near shrubs or trees, keep them trimmed so they do not interfere with air flow.

Recommended iStore Servicing

2 Year Service

The recommended two-yearly service should be carried out by a licensed tradesperson. It is recommended that this service be carried out by your local iStore installer. The service should include the following:

1. Replace the anode (anodes should be replaced more frequently if subjected to hard water conditions, refer table in the warranty exclusions, iStore must be consulted regarding the replacement anode if not a genuine iStore anode). If the TDS is greater than 600PPM, the anode shall be inspected every year and replaced at intervals not greater than every 12 months

5 Year Service

1. Replace the anode (anodes should be replaced more frequently if subjected to hard water conditions, refer table in the warranty exclusions, iStore must be consulted regarding the replacement anode if not a genuine iStore anode). If the TDS is greater than 600PPM, the anode shall be inspected every year and replaced at intervals not greater than every 12 months
2. Replace the pressure & temperature relief valve. (PTR Valve)
3. Flush the water heater
4. Check and clean tempering valve filters and operation

Maintenance and Repair

5.1 Typical Failure and Solutions

Maintenance of the system is very easy and includes the following tasks:

Malfunction	Display	Problem	Solution
Bottom water temp. Failure	P01	The water bottom temp. sensor is open or short circuit	Check or change the water bottom temp. sensor
Top tank water temp. Failure	P02	The water top tank temp. sensor is open or short circuit	Check or change the water top tank temp. sensor
Ambient temp. Failure	P04	The ambient temp. sensor is open or short circuit	Check or change the ambient temp. sensor
Coil temp. Failure	P05	The pipe temp. sensor is open or short circuit	Check or change the pipe temp. sensor
Refrigerant absorb temp. Failure	P07	The evaporator temp. sensor is open or short circuit	Check or change the evaporator temp. sensor
Anti-freeze temp. Failure	P09	The anti-freeze temp. sensor is open or short circuit	Check or change the anti-freeze temp. sensor
High pressure protection	E01	The exhaust pressure is high, high pressure switch action	Check high pressure switch and cooling return circuit
Low pressure protection	E02	The suction pressure is low, low pressure switch action	Check low pressure switch and cooling return circuit
Communication failure	E08	Wired remote control with master signal failure	Check the connection line between the wired remote control and motherboard
Winter frost protection	E09	Ambient temperature is too low	

How to Drain the Water Heater

Warning: Before commencing this procedure, ensure that building occupants are notified to stay clear of the iStore system components and building perimeter as steam or hot water may be discharged from pipes or components

1. Turn off the electricity supply and tag out
2. Close the cold water mains supply via the Isolation Valve
3. Release pressure from the system by activating the PTR valve
4. Locate drain port at the bottom of the tank and unscrew the plug
5. The system will now drain all water

Note: At this stage the water heater can be flushed by removing the hot water outlet connection and hosing out any debris that may be present.

Appendix



Warning: only to be performed by licenced technicians

Use of the Overheating Protector

The overheating protector is used to turn the power off, preventing the water from being heated too high. To return the unit to its normal operational status it will have to be reset manually by qualified personnel.

The thermal cut-out is pre-installed in the system, no on-site installation or commissioning is required. The recommended factory setting is 60° Celsius to prevent the thermal cut-out from operating. The thermal cut-out operation temperature is 85° Celsius.

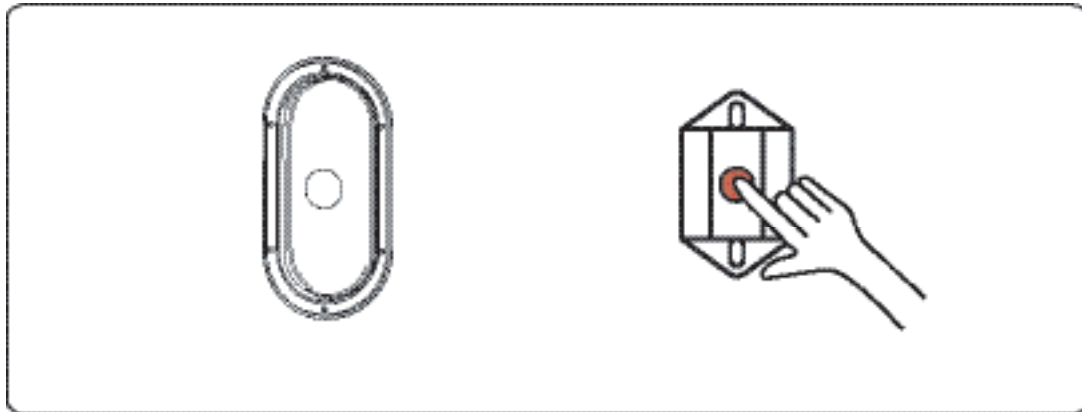

Loosen the screws and open the cover

Push the red button

Earthing (Applicable where 3 pin plug is either not fitted or removed)

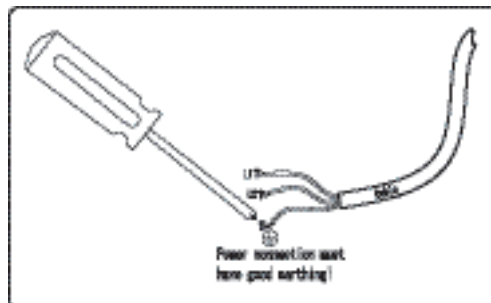

Troubleshooting

PROBLEM	SOURCE	EXPLANATION
Water not as hot as previous hot water system	Tempering Valve installed	A tempering valve must be installed on every solar hot water system. Tempering valves will mix water down to 50°C.
No Power at Screen	Circuit breaker turned off AC Isolator Turned Off Power surge	Check Circuit breaker in meter box Check AC Isolator in on position Contact iStore
No Hot Water - 1	Faulty Tempering Valve	Pull PTR lever and check if water is hot. If water is hot, contact a licensed plumber to replace tempering valve.
No Hot Water - 2	Off-Peak Tariff	Check screen to see if power is available during your nominated off-peak tariff heating times. Refer to your electricity distributor should power not be available from off-peak supply
No Hot Water - 3	Timer not set correctly	Ensure that timer is set to heat to your hot water demands. A secondary heating cycle maybe required if large hot water demand is used twice per day. Refer above instructions for timer settings
Luke Warm Hot Water - 1	Tempering Valve	Tempering valve not mixing water correctly. Contact a licensed plumber to inspect / replace the valve
Luke Warm Hot Water - 2	Excessive Hot Water load	Unexpected additional hot water load. Plan hot water usage to be staggered, not continuous consumption. Wait for system to re-heat. Increase timer setting if in use.
Overflow pipe is dripping	Pressure Temperature Relief Valve (PTR) / Expansion Control Valve (ECV) where applicable.	An 850kPa and 99°C PTR valve is used on the iStore water tank, which is located on the side of the water tank and is essential for its safe operation. The PTR valve / ECV valves are designed to allow approx. 3-5% of total tank volume to discharge during heating to cater for hot water expansion
Water pressure is slightly lower than previous hot water system	Pressure Reduction Valve (PRV)	A pressure reduction valve has been installed to limit the inlet pressure to your new iStore Water Heater. This device regulates the incoming pressure & increases life of the cylinder. This device will also protect your cylinder if the mains pressure is increased by the local water authority.

Further Assistance? Go to the FAQ

Need some further assistance then please review the extensive Frequently Asked Questions at <https://heatpumps.istore.net.au/frequently-asked-questions>



Terms and Conditions of Warranty

1. For all warranty issues please call iStore on 1300 552 619 or info@istore.net.au
2. This Warranty is effective for all iStore Hot Water Systems manufactured and installed after 1st October 2022.
3. If the customer has not paid in full for the iStore Hot Water System then this Warranty does not apply.
4. iStore Hot Water System and its components are covered by a warranty against defective factory parts or workmanship from the date the iStore Hot Water System is installed for the relevant period for such component as outlined in Table 1 - Warranty Periods. If the date of installation is unknown, the Warranty commences one (1) Month after the date of manufacture.
5. This Warranty is for normal domestic use of the iStore Hot Water system only.
6. To the extent a claim falls under the "Parts Only" Warranty Period the Warranty covers the replacement only of such failed component in the iStore Hot Water System free of charge. Subject to an area within a 30-kilometre radius of the iStore Branch or Authorised Distributor from where the unit was purchased. Customers outside this area will be subject to any freight costs and any travelling charges incurred by the iStore representative carrying out the rectification. "Parts Only" Warranty period excludes labour.
7. To the extent a claim falls under the "Parts and Labour" Warranty Period, the Warranty covers the repair and/or replacement of such failed component in the iStore Hot Water System and any associated labour costs free of charge. Subject to an area within a 30-kilometre radius of the iStore Branch or Authorised Distributor from where the unit was purchased. Customers outside this area will be subject to any freight costs and any travelling charges incurred by the iStore representative carrying out the rectification.
8. The decision to repair or replace the component the subject of the Warranty will be entirely at the discretion of iStore.
9. Where a iStore Hot Water System or a component thereto is repaired or replaced by iStore, the balance of any original Warranty Period will remain effective. The repaired or replaced part does not carry any additional warranty period.
10. Upon installation of the iStore Hot Water System, it is the consumer's responsibility to register their warranty on-line <https://heatpumps.istore.net.au/warranty-registration>. Consumer must provide the following detail - home owners detail, product model number, product installation date, product serial numbers, licensed plumber contact details. Once you have successfully completed the on-line registration form, you will be notified of successful warranty registration. If you do not have access to the internet, please contact iStore on 1300 552 619 to register your warranty. To be eligible to make a claim under this warranty, consumer must register their warranty within 6 weeks of the installation.
11. The iStore Hot Water System must be installed in accordance with iStore's installation instructions, and all relevant local, state and national statutory requirements, including but not limited to, AS3500,4 & 5, AS5601, AS3000, AS2712 and AS/NZS1677.
12. Installation must be completed by licensed plumbers and electricians that are licensed in the State or Territory in which the installation is completed. Installation must include all relevant valves as required by federal/state regulations & shall incorporate a 500kPa Pressure Reduction Valve. Installation of a Pressure Limiting Valve does not comply with manufactures installation instructions. Failure to incorporate a 500kPa Pressure Reduction Valve will void this warranty.
13. The electrical system components must be installed in a domestic application and connected to a 240V power supply by a qualified electrician in accordance with AS3000.
14. iStore reserves the right to alter the design, components or construction to its iStore Hot Water System. Such alterations shall not constitute a defect in design or construction under this Warranty. Any claim under this Warranty must include full details of the defect and/or damage to the iStore System. All claims must be made within one (1) month of detection of the defect.

Terms and Conditions of Warranty

15. Dated proof of purchase is required prior to commencement of any work under this Warranty. This Warranty does not apply to any defects or damage NOT due to faulty factory parts or workmanship including, but not limited to, defects or damage caused by or resulting from: (a) accidental damage, storm damage, vandalism, failure due to misuse or abuse, or neglect of any kind; (b) incorrect or improper installation of the iStore Hot Water System, including but not limited to, installation otherwise than in accordance with the instructions contained in the installation manual supplied by iStore or incorrect system selection; (c) alteration or repair of the iStore Hot Water System other than by a licensed plumber/electrician/refrigeration mechanic or by an approved iStore agent; (d) attachment of any parts or accessories other than those manufactured or approved by iStore; (e) freezing in regions with minimum temperatures below -10°C; (f) the power supply to the iStore Hot Water System being cut; (g) power surges; (h) animals, birds and/or rodents; (i) excessive water pressure, negative pressure (partial vacuum), excessive temperature, corrosive atmosphere, faulty plumbing and/or electrical wiring; (j) sludge/sediment as a result of connection to a water supply from unfiltered or treated sources i.e. spring, dam, bore, river or town supply from a bore; (k) contamination and corrosion from particles in the water supply; (l) serial tags/stickers on any of the components being removed or defaced; (m) the iStore Hot Water System being relocated from its original point of installation; (n) the water stored in the cylinder exceeding at any time the following levels: (o) If penetrations are made through the tank skin by the installer, warranty will be void immediately; (p) Damage caused by transport; (q) if the system has been re-installed at a location other than the original location.
16. iStore does not warrant any work conducted by a third-party installer of the iStore Hot Water System.
17. This Warranty only applies to the iStore Hot Water System and its components and does not cover any plumbing or electrical associated parts, including but not limited to any parts supplied by any person installing the iStore Hot Water System.
18. To the extent permitted by law, iStore shall not be liable under this Warranty for any consequential loss or damage or any incidental expenses resulting from any breach of this warranty, including but not limited to, claims for damage to buildings, roofs, ceilings, walls, foundations, gardens, personal belonging or household effects, fixtures and fittings. Or any other consequential loss, damage or inconvenience, either directly or indirectly due to leakage from the iStore Hot Water System or any other matter related to the system or its operation.
19. The benefits conferred by this Warranty are in addition to all other rights and remedies in respect of the iStore Hot Water System, which the purchaser has under the Competition and Consumer Act 2010 and consumer protection legislation of the States and Territories. Nothing in this Warranty has the effect of excluding, restricting or modifying those rights.
20. Goods presented for repair may be replaced by refurbished goods of same type rather than being repaired. Refurbished parts may be used to repair/replace the goods.
21. Our goods come with guarantees that cannot be excluded under the Australian Consumer Law. You are entitled to a replacement or refund for a major failure and compensation for any other reasonably foreseeable loss or damage. You are also entitled to have the goods repaired or replaced if the goods fail to be of acceptable quality and the failure does not amount to a major failure.
22. iStore strongly recommends that the consumer update their household insurance policy.

Total hardness	200 mg/litre or p.p.m
Total dissolved solids	600 mg/litre or p.p.m
Electrical conductivity	850 μ S/cm
Chloride	250 mg/litre or p.p.m
Magnesium	10 mg/litre or p.p.m
Sodium	150 mg/litre or p.p.m
pH	Min 6.5 to Max 8.5

Component Warranty Table

This warranty is effective for all iStore hot water systems manufactured and installed after 1st October 2022.

COMPONENT	WARRANTY PERIOD (Parts Only)	WARRANTY PERIOD (Parts and Labour)
iStore Glass Lined Tank	5 years	5 years
Refrigeration	5 years	5 years
Electrical (controller and sensor leads)	5 years	5 years
Sacrificial Anode & PTR valve	1 year	1 year
Consumable Items	1 year	1 year

After Sales Service Guaranteed

Thank you for joining iStore in our mission to lead the way to a sustainable energy future.

Supplier Name: _____ Installation Date: _____

Supplier Address: _____ Supplier Phone: _____

System Model / Type: _____